

FRANCE
TRULUME
LED MODULES

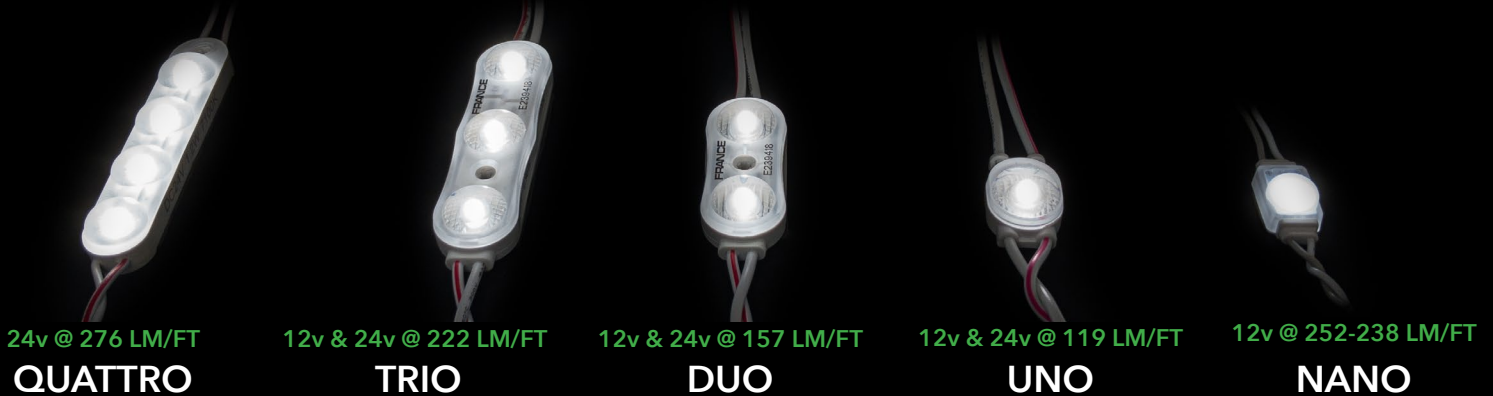

MORE LIGHT. LESS POWER.



LOWER SYSTEM COST
GET 100 MODULES ON
1 (60W) POWER SUPPLY

HIGH PERFORMING OPTICS
SHALLOW, DEEP, SKINNY, OR
WIDE WE HAVE YOU COVERED

MAXIMUM EFFICIENCY
AVERAGE 150 LUMENS PER WATT
VERIFIED BY 3RD PARTY, INTERTEK

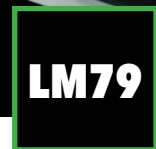
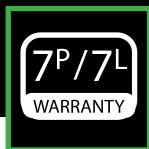
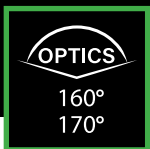

ASK YOUR DISTRIBUTOR OR OUR REPRESENTATIVE FOR MORE INFORMATION



FranceLEDProducts.com
2268 Fairview Blvd.
Fairview, TN 37062
sales@sfg.com
800.793.4793

KOR
VISUAL GROUP
building significant brands

U.S. & CANADA REPRESENTATIVES

SCOTT CUTCHER
Central & Eastern U. S. | Eastern Canada

CALVIN ROLLYSON
Western U. S. | Western Canada

EMAIL: SALES@KORVISUALGROUP.COM | PHONE: (615)-900-0966

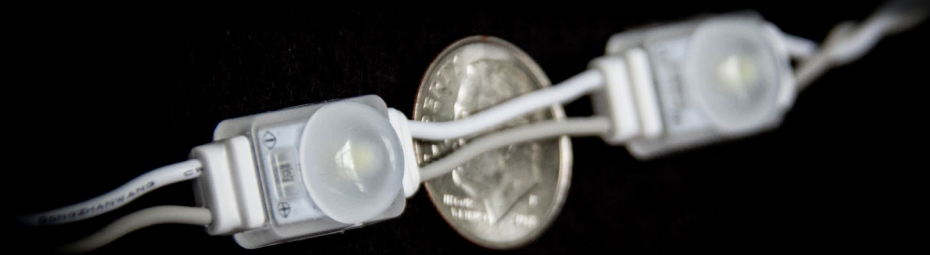

CORE APPLICATIONS:

CHANNEL LETTERS

> SMALL | SHALLOW | THIN

ACCENT & COVE LIGHTING

SMALL MOLDED / ACRYLIC LETTERS



TINY BUT MIGHTY

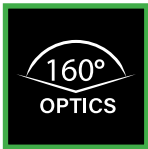

TRULUME MODULE TYPE	PRODUCT NUMBER	TEMPS / COLORS	LUMEN PER MOD	EFFICIENCY	LUMENS PER FT	MODS PER FT	POWER PER MODS / FT	# MODS / FT PER 60W P. S.	MAX. SERIAL CONNECTION	MODS/FT PER BAG	BAGS PER CARTON
12v Nano 71K	20709-01	7100K	36	100 Lm/W	252	7	0.36 W {2.52 W FT.}	166 Mods {23 FT.}	45 Mods {6 FT.}	400 Mods {57 FT.}	14 Bags {5,600 MODS}
12v Nano 5K	20709-02	5000K	34	94 Lm/W	238	7					
12v Nano 35K	20709-03	3500K	34	94 Lm/W	238	7					
12v Nano Red	20709-04	625nm	12	33 Lm/W	84	7					
12v Nano Green	20709-05	525nm	15	41 Lm/W	105	7					
12v Nano Blue	20709-06	460nm	7	19 Lm/W	49	7					

Note: Custom Kelvin Temperatures Available Upon Request

LIGHT BEAM PATTERN

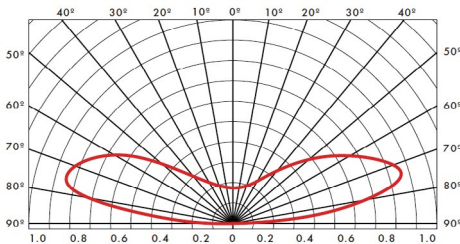

160° Lens

SPACING & USAGE CHART

CHANNEL / SIGN DEPTH	2"	3"	4"	5"
Single Row Spacing - Max Stoke	4"	6"	8"	10"
Multiple Row Spacing	3"	4"	6"	8"



NOTE: Product and depth may vary depending on face material and desired brightness. Testing conducted using 7328 acrylic.

QUICK LINKS

CLICKABLE ON PDF ONLY

[WHITE MODULE SELECTION GUIDE](#)

[COLOR MODULE SELECTION GUIDE](#)

[12V NANO PRODUCT VIDEO](#)

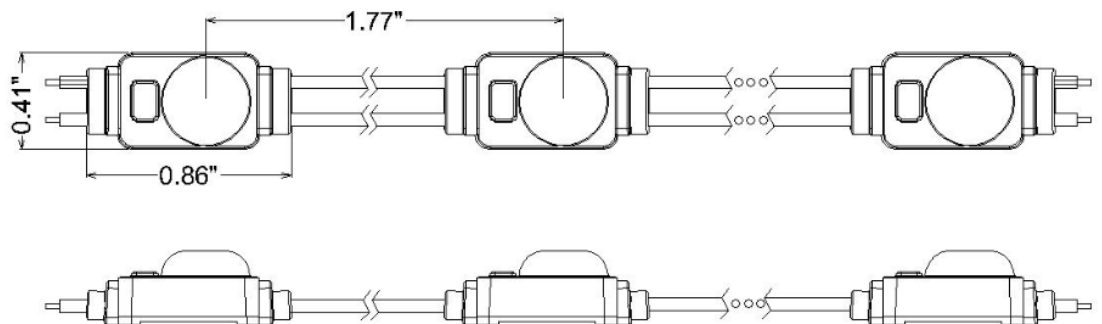



CORE APPLICATIONS:

- CHANNEL LETTERS
 - > SMALL | SHALLOW | THIN
- ACCENT LIGHTING
- COVE LIGHTING



GREAT LENS. SMALL BODY.

L70
5+
years
LIFESPAN

7P/7L
WARRANTY

IP67
DRY / DAMP / WET

-40°
140°
OPERATING
TEMPERATURE

TOTAL SYSTEM
\$

MECHANICAL
FASTENING

EASY PEEL
3M
VHB
LINER

CCT RANGE
SINGLE BIN

TRU
CONSTANT
CURRENT

TRULUME MODULE TYPE	PRODUCT NUMBER	TEMPS / COLORS	LUMEN PER MOD	EFFICIENCY	LUMENS PER FT	MODS PER FT	POWER PER MODS / FT	# MODS / FT PER 60W P. S.	MAX. SERIAL CONNECTION	MODS/FT PER BAG	BAGS PER CARTON
12v Uno 71K	19842-01	7100K	53	148 Lm/W	119	2.26	0.36 W {0.82 W FT.}	166 Mods {73 FT.}	45 Mods {19 FT.}	135 Mods {59 FT.}	20 Bags {2,700 MODS}
12v Uno 5K	19842-02	5000K	53	148 Lm/W	119	2.26					
12v Uno 35K	19842-03	3500K	53	148 Lm/W	119	2.26					
12v Uno Red	19842-04	625nm	14	38 Lm/W	31	2.26					
12v Uno Green	19842-05	525nm	18	50 Lm/W	40	2.26					
12v Uno Blue	19842-06	460nm	7	19 Lm/W	15	2.26					

Note: Custom Kelvin Temperatures Available Upon Request

LIGHT BEAM PATTERN

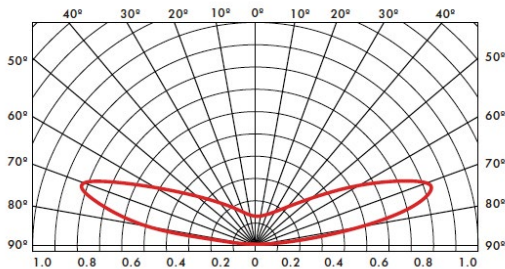

170° Lens

SPACING & USAGE CHART

CHANNEL / SIGN DEPTH	2"	3"	4"	5"
Single Row Spacing - Max Stoke	6"	7"	8"	10"
Multiple Row Spacing	4"	5"	6"	8"

NOTE: Product and depth may vary depending on face material and desired brightness. Testing conducted using 7328 acrylic.



QUICK LINKS

CLICKABLE ON PDF ONLY

WHITE MODULE SELECTION GUIDE

COLOR MODULE SELECTION GUIDE

12V UNO PRODUCT VIDEO

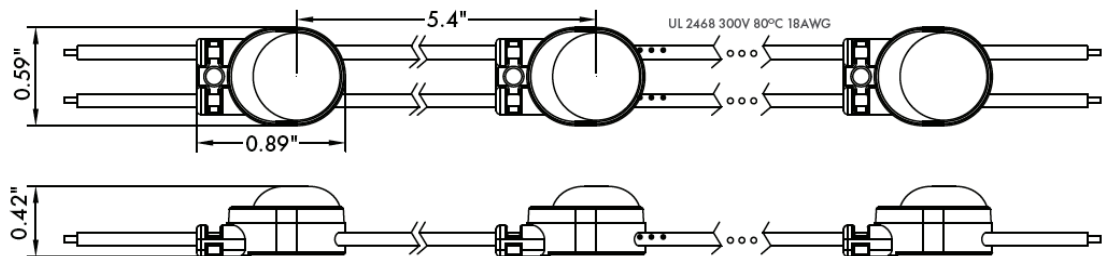

12v DUO

170°
OPTICS

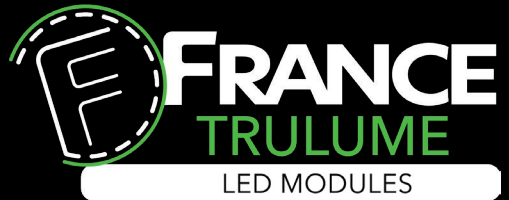

CORE APPLICATIONS:

CHANNEL LETTERS

> STANDARD | SHALLOW | WIDE

ACCENT & COVE LIGHTING

SHALLOW CABINET / BOX SIGNS



YOUR EVERYDAY WORKHORSE

- L70 5+ years LIFESPAN**
- 7P/7L WARRANTY**
- IP67 DRY / DAMP / WET**
- 40° ~ 140° OPERATING TEMPERATURE**
- TOTAL SYSTEM**
- MECHANICAL FASTENING**
- EASY PEEL 3M VHB LINER**
- CCT RANGE SINGLE BIN**
- TRU CONSTANT CURRENT**

TRULUME MODULE TYPE	PRODUCT NUMBER	TEMPS / COLORS	LUMEN PER MOD	EFFICIENCY	LUMENS PER FT	MODS PER FT	POWER PER MODS / FT	# MODS / FT PER 60W P. S.	MAX. SERIAL CONNECTION	MODS/FT PER BAG	BAGS PER CARTON
12v Duo 71K	19843-01	7100K	93	155 Lm/W	157	1.69	0.60 W {1.0 W FT.}	100 Mods {59 FT.}	40 mods {23 FT.}	80 Mods {47 FT.}	18 Bags {1,440 MODS}
12v Duo 5K	19843-02	5000K	93	155 Lm/W	157	1.69					
12v Duo 35K	19843-03	3500K	93	155 Lm/W	157	1.69					
12v Duo Red	19843-04	625nm	28	46 Lm/W	47	1.69					
12v Duo Green	19843-05	525nm	36	60 Lm/W	60	1.69					
12v Duo Blue	19843-06	460nm	14	23 Lm/W	23	1.69					

Note: Custom Kelvin Temperatures Available Upon Request

LIGHT BEAM PATTERN

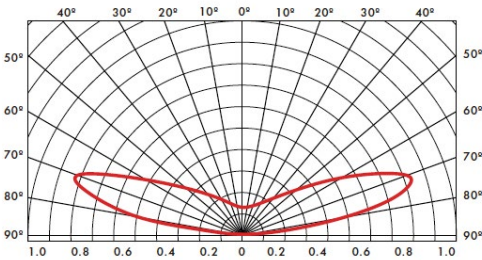

170° Lens

SPACING & USAGE CHART

CHANNEL / SIGN DEPTH	2"	3"	4"	5"
Single Row Spacing - Max Stoke	6"*	10"	12"	14"
Multiple Row Spacing	6"*	8"	10"	12"

Note: Product and depth may vary depending on face material and desired brightness. Testing conducted using 7328 acrylic.

*Have to move in modules approximately a third of the distance. Testing for verification is needed



QUICK LINKS

CLICKABLE ON PDF ONLY

WHITE MODULE SELECTION GUIDE

COLOR MODULE SELECTION GUIDE

12V DUO PRODUCT VIDEO

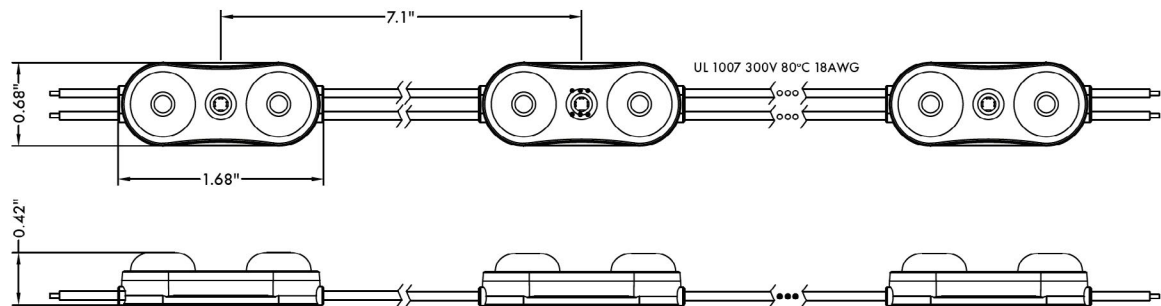

FRANCE TRULUME LED MODULES NAVIGATION

12v NANO | 12v UNO | 12v DUO | 12v TRIO | 24v UNO | 24v DUO | 24v TRIO | 24v QUATTRO

WHITE LED COMPARISON CHART | COLOR LED COMPARISON CHART

12v TRIO



170°
OPTICS



CORE APPLICATIONS:

CHANNEL LETTERS

> STANDARD | SHALLOW | WIDE | DEEP

CABINET / BOX SIGNS

> STANDARD | SHALLOW | CLOUD

ACCENT & COVE LIGHTING

THE DUO'S BIG BROTHER

L70 5+ years LIFESPAN	7P/7L WARRANTY	IP67 DRY / DAMP / WET	-40° 140° OPERATING TEMPERATURE	TOTAL SYSTEM \$	MECHANICAL FASTENING	EASY PEEL 3M VHB LINER	CCT RANGE SINGLE BIN	TRU CONSTANT CURRENT
---------------------------------------	--------------------------	---------------------------------	--	---------------------------	--------------------------------	--	--------------------------------	-----------------------------------

TRULUME MODULE TYPE	PRODUCT NUMBER	TEMPS / COLORS	LUMEN PER MOD	EFFICIENCY	LUMENS PER FT	MODS PER FT	POWER PER MODS / FT	# MODS / FT PER 60W P. S.	MAX. SERIAL CONNECTION	MODS/FT PER BAG	BAGS PER CARTON
12v Trio 71K	19844-01	7100K	148	154 Lm/W	222	1.5	0.96 W {1.44 W FT.}	60 Mods {40 FT.}	25 Mods {16 FT.}	50 Mods {33 FT.}	16 Bags {800 MODS}
12v Trio 5K	19844-03	5000K	148	154 Lm/W	222	1.5					
12v Trio 35K	19844-04	3500K	148	154 Lm/W	222	1.5					
12v Trio Red	19844-02	625nm	42	43 Lm/W	63	1.5					
12v Trio Green	19844-05	525nm	54	56 Lm/W	81	1.5					
12v Trio Blue	19844-06	460nm	21	21 Lm/W	31	1.5					

LIGHT BEAM PATTERN

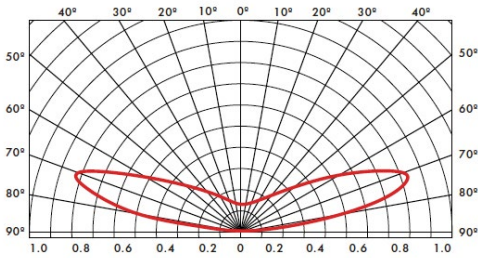

170° Lens

Note: Custom Kelvin Temperatures Available Upon Request

SPACING & USAGE CHART

CHANNEL / SIGN DEPTH	2"	3"	4"	5"
Single Row Spacing- Max Stroke	7*	10"	12"	14"
Multiple Row Spacing	6*	9"	11"	13"

Note: Product and depth may vary depending on face material and desired brightness. Testing conducted using 7328 acrylic.

*Have to move in modules approximately a third of the distance.

Testing for verification is needed



QUICK LINKS

CLICKABLE ON PDF ONLY

WHITE MODULE SELECTION GUIDE

COLOR MODULE SELECTION GUIDE

12V TRIO PRODUCT VIDEO

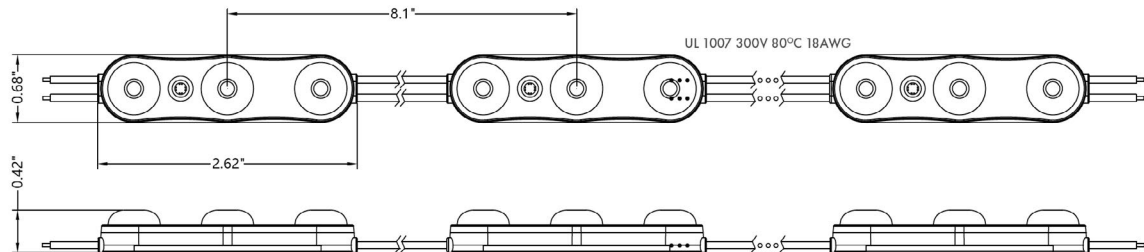

FRANCE TRULUME LED MODULES NAVIGATION

12v NANO | 12v UNO | 12v DUO | 12v TRIO | 24v UNO | 24v DUO | 24v TRIO | 24v QUATTRO

WHITE LED COMPARISON CHART | COLOR LED COMPARISON CHART



CORE APPLICATIONS:

- CHANNEL LETTERS
 - > SMALL | SHALLOW | THIN
- ACCENT LIGHTING
- COVE LIGHTING



GREAT LENS. SMALL BODY.

- L70 5+ years LIFESPAN**
- 7P/7L WARRANTY**
- IP67 DRY / DAMP / WET**
- 40° ~ 140° OPERATING TEMPERATURE**
- TOTAL SYSTEM**
- MECHANICAL FASTENING**
- EASY PEEL 3M VHB LINER**
- CCT RANGE SINGLE BIN**
- TRU CONSTANT CURRENT**

TRULUME MODULE TYPE	PRODUCT NUMBER	TEMPS / COLORS	LUMEN PER MOD	EFFICIENCY	LUMENS PER FT	MODS PER FT	POWER PER MODS / FT	# MODS / FT PER 60W P. S.	MAX. SERIAL CONNECTION	MODS/FT PER BAG	BAGS PER CARTON
24v Uno 71K	20864-01	7100K	53	148 Lm/W	119	2.26	0.36 W {0.82 W FT.}	266 Mods {73 FT.}	45 Mods {19 FT.}	135 Mods {59 FT.}	20 Bags {2,700 MODS}
24v Uno 5K	20864-02	5000K	53	148 Lm/W	119	2.26					
24v Uno 35K	20864-03	3500K	53	148 Lm/W	119	2.26					
24v Uno Red	20864-04	625nm	14	38 Lm/W	31	2.26					
24v Uno Green	20864-05	525nm	18	50 Lm/W	40	2.26					
24v Uno Blue	20864-06	460nm	7	19 Lm/W	15	2.26					

Note: Custom Kelvin Temperatures Available Upon Request

LIGHT BEAM PATTERN

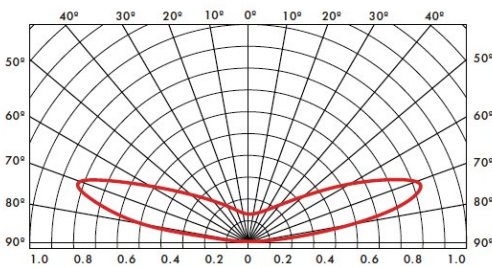

170° Lens

SPACING & USAGE CHART

CHANNEL / SIGN DEPTH	2"	3"	4"	5"
Single Row Spacing - Max Stoke	6"	7"	8"	10"
Multiple Row Spacing	4"	5"	6"	8"

NOTE: Product and depth may vary depending on face material and desired brightness. Testing conducted using 7328 acrylic.



QUICK LINKS

- [CLICKABLE ON PDF ONLY](#)
- [WHITE MODULE SELECTION GUIDE](#)
- [COLOR MODULE SELECTION GUIDE](#)
- [24V UNO PRODUCT VIDEO - COMING SOON](#)

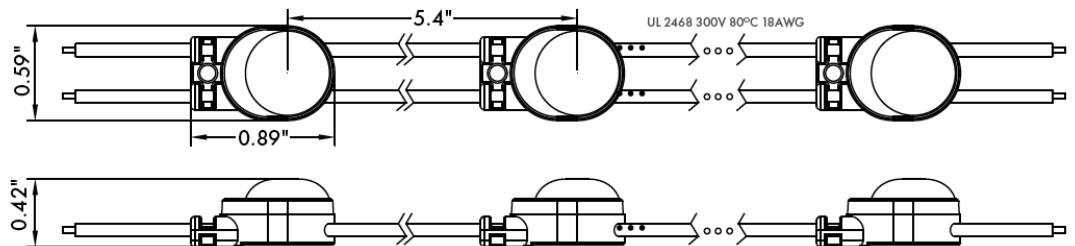

24v DUO



LED MODULES

CORE APPLICATIONS:

CHANNEL LETTERS

> WIDE | DEEP

CABINET / BOX SIGNS

> STANDARD | CLOUD

ACCENT & COVE LIGHTING

170° OPTICS



YOUR EVERYDAY WORKHORSE

L70 5+ years LIFESPAN	7P/7L WARRANTY	IP67 DRY / DAMP / WET	-40° ~140° OPERATING TEMPERATURE	TOTAL SYSTEM \$	MECHANICAL FASTENING	EASY PEEL 3M VHB LINER	CCT RANGE SINGLE BIN	CC TRU CONSTANT CURRENT
------------------------------------	--------------------------	---------------------------------	---	---------------------------	--------------------------------	----------------------------------	--------------------------------	-----------------------------------

TRULUME MODULE TYPE	PRODUCT NUMBER	TEMPS / COLORS	LUMEN PER MOD	EFFICIENCY	LUMENS PER FT	MODS PER FT	POWER PER MODS / FT	# MODS / FT PER 100W P. S.	MAX. SERIAL CONNECTION	MODS/FT PER BAG	BAGS PER CARTON
24v Duo 71K	19845-01	7100K	93	155 Lm/W	157	1.69	0.60 W {1.0 W FT.}	160 Mods {98 FT.}	40 Mods {23 FT.}	80 Mods {47 FT.}	18 Bags {1,440 MODS}
24v Duo 5K	19845-02	5000K	93	155 Lm/W	157	1.69					
24v Duo 35K	19845-03	3500K	93	155 Lm/W	157	1.69					
24v Duo Red	19845-04	625nm	28	46 Lm/W	47	1.69					
24v Duo Green	19845-05	525nm	36	60 Lm/W	60	1.69					
24v Duo Blue	19845-06	460nm	14	23 Lm/W	23	1.69					

Note: Custom Kelvin Temperatures Available Upon Request

LIGHT BEAM PATTERN

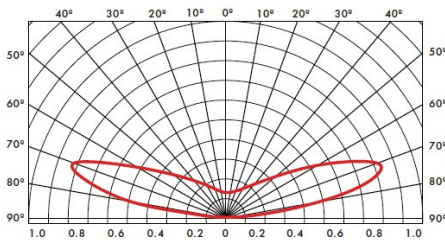

170° Lens

SPACING & USAGE CHART

CHANNEL / SIGN DEPTH	2"	3"	4"	5"
Single Row Spacing - Max Stroke	6*	10"	12"	14"
Multiple Row Spacing	6*	8"	10"	12"

Note: Product and depth may vary depending on face material and desired brightness. Testing conducted using 7328 acrylic.

*Have to move in modules approximately a third of the distance. Testing for verification is needed



QUICK LINKS

CLICKABLE ON PDF ONLY

WHITE MODULE SELECTION GUIDE

COLOR MODULE SELECTION GUIDE

24V DUO PRODUCT VIDEO

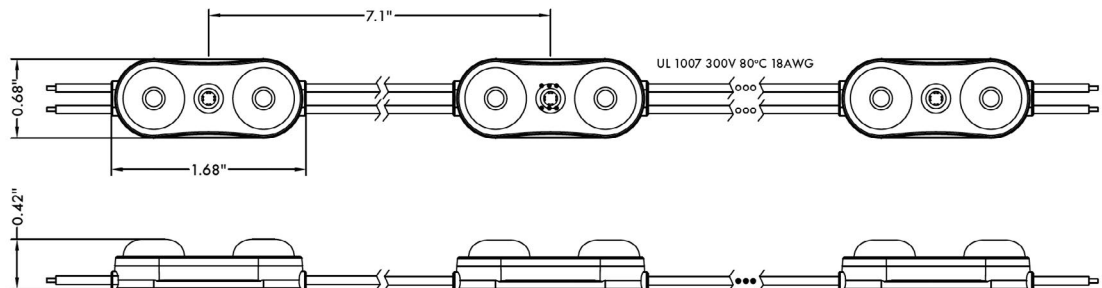

FRANCE TRULUME LED MODULES NAVIGATION

12v NANO | 12v UNO | 12v DUO | 12v TRIO | 24v UNO | 24v DUO | 24v TRIO | 24v QUATTRO

WHITE LED COMPARISON CHART | COLOR LED COMPARISON CHART

24v TRIO



LED MODULES

170°
OPTICS



CORE APPLICATIONS:

CHANNEL LETTERS

> STANDARD | SHALLOW | WIDE | DEEP

CABINET / BOX SIGNS

> STANDARD | SHALLOW | CLOUD

ACCENT & COVE LIGHTING

THE DUO'S BIG BROTHER

L70 5+ years LIFESPAN	7P/7L WARRANTY	IP67 DRY / DAMP / WET	-40° 140° OPERATING TEMPERATURE	TOTAL SYSTEM \$	MECHANICAL FASTENING	EASY PEEL 3M VHB LINER	CCT RANGE SINGLE BIN	TRU CONSTANT CURRENT
---------------------------------------	--------------------------	---------------------------------	--	---------------------------	--------------------------------	--	--------------------------------	-----------------------------------

TRULUME MODULE TYPE	PRODUCT NUMBER	TEMPS / COLORS	LUMEN PER MOD	EFFICIENCY	LUMENS PER FT	MODS PER FT	POWER PER MODS / FT	# MODS / FT PER 60W P. S.	MAX. SERIAL CONNECTION	MODS/FT PER BAG	BAGS PER CARTON
24v Trio 71K	20859-01	7100K	148	154 Lm/W	222	1.5	0.96 W {1.44 W FT.}	100 Mods {40 FT.}	25 Mods {16 FT.}	50 Mods {33 FT.}	16 Bags {800 MODS}
24v Trio 5K	20859-02	5000K	148	154 Lm/W	222	1.5					
24v Trio 35K	20859-03	3500K	148	154 Lm/W	222	1.5					
24v Trio Red	20859-04	625nm	42	43 Lm/W	63	1.5					
24v Trio Green	20859-05	525nm	54	56 Lm/W	81	1.5					
24v Trio Blue	20859-06	460nm	21	21 Lm/W	31	1.5					

Note: Custom Kelvin Temperatures Available Upon Request

LIGHT BEAM PATTERN

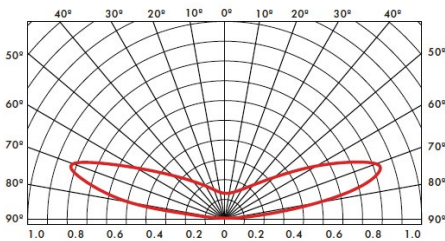

170° Lens

SPACING & USAGE CHART

CHANNEL / SIGN DEPTH	2"	3"	4"	5"
Single Row Spacing- Max Stroke	7*	10"	12"	14"
Multiple Row Spacing	6*	9"	11"	13"

Note: Product and depth may vary depending on face material and desired brightness. Testing conducted using 7328 acrylic.

*Have to move in modules approximately a third of the distance.

Testing for verification is needed



QUICK LINKS

CLICKABLE ON PDF ONLY

WHITE MODULE SELECTION GUIDE

COLOR MODULE SELECTION GUIDE

24V TRIO PRODUCT VIDEO

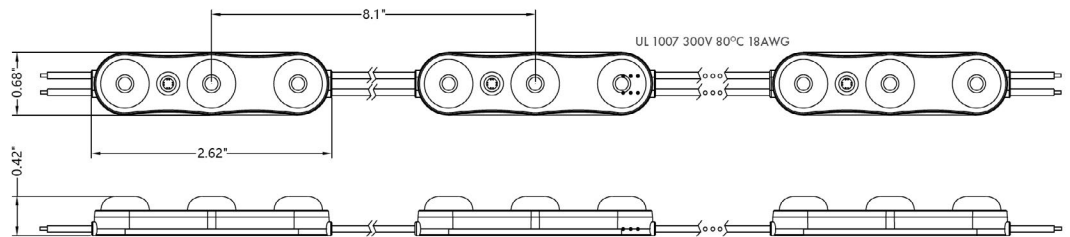

FRANCE TRULUME LED MODULES NAVIGATION

12v NANO | 12v UNO | 12v DUO | 12v TRIO | 24v UNO | 24v DUO | 24v TRIO | 24v QUATTRO

WHITE LED COMPARISON CHART | COLOR LED COMPARISON CHART



24v QUATTRO



170°
OPTICS



CORE APPLICATIONS:

CHANNEL LETTERS

> WIDE | DEEP

CABINET / BOX SIGNS

> STANDARD | CLOUD

ACCENT & COVE LIGHTING



THE 24V POWERHOUSE

- L70 5+ years LIFESPAN**
- 7P/7L WARRANTY**
- IP67 DRY / DAMP / WET**
- 40° ~ 140° OPERATING TEMPERATURE**
- TOTAL SYSTEM**
- MECHANICAL FASTENING**
- EASY PEEL 3M VHB LINER**
- CCT RANGE SINGLE BIN**
- TRU CONSTANT CURRENT**

TRULUME MODULE TYPE	PRODUCT NUMBER	TEMPS / COLORS	LUMEN PER MOD	EFFICIENCY	LUMENS PER FT	MODS PER FT	POWER PER MODS / FT	# MODS / FT PER 100W P. S.	MAX. SERIAL CONNECTION	MODS/FT PER BAG	BAGS PER CARTON
24v Quattro 71K	19846-01	7100K	184	153 Lm/W	276	1.5	1.2 W {1.80 W FT.}	80 Mods {53 FT.}	40 Mods {26 FT.}	80 Mods {53 FT.}	12 Bags {960 MODS}
24v Quattro 5K	19846-02	5000K	184	153 Lm/W	276	1.5					
24v Quattro 35K	19846-03	3500K	184	153 Lm/W	276	1.5					
24v Quattro Red	19846-04	625nm	45	38 Lm/W	67	1.5					
24v Quattro Green	19846-04	525nm	56	47 Lm/W	68	1.5					
24v Quattro Blue	19846-04	460nm	16	14 Lm/W	19	1.5					

Note: Custom Kelvin Temperatures Available Upon Request

LIGHT BEAM PATTERN

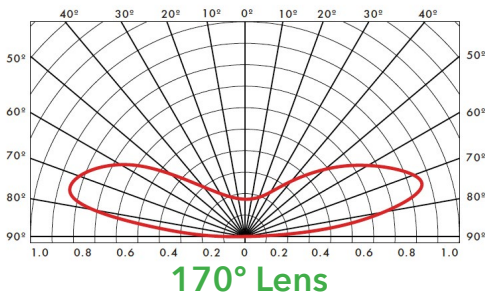

SPACING & USAGE CHART

CHANNEL / SIGN DEPTH	3"	4"	5"	6"
Single Row Spacing - Max Stoke	10"	12"	14"	14"
Multiple Row Spacing	8"	10"	12"	12"

Note: Product and depth may vary depending on face material and desired brightness. Testing conducted using 7328 acrylic.



QUICK LINKS

CLICKABLE ON PDF ONLY

WHITE MODULE SELECTION GUIDE

COLOR MODULE SELECTION GUIDE

24V QUATTRO PRODUCT VIDEO

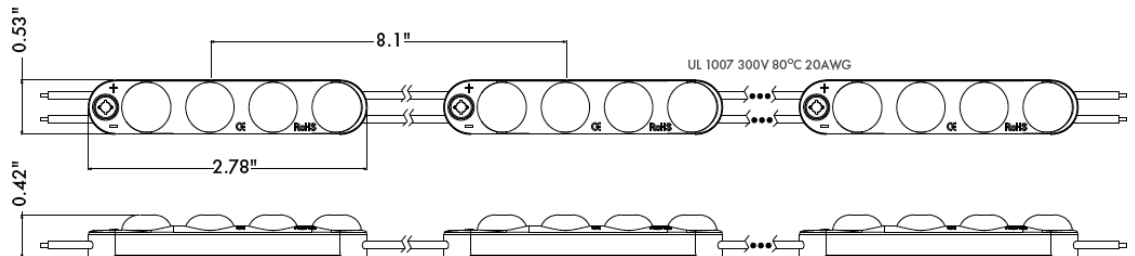

FRANCE TRULUME LED MODULES NAVIGATION

12v NANO | 12v UNO | 12v DUO | 12v TRIO | 24v UNO | 24v DUO | 24v TRIO | 24v QUATTRO

WHITE LED COMPARISON CHART | COLOR LED COMPARISON CHART



LED MODULES COMPARISON CHART

WHITE LED MODULES

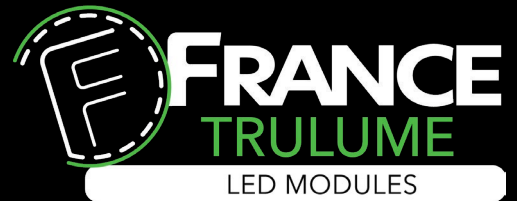

WHITE LED MODULES COMPARISON CHART

TRULUME MODULE MODEL	VOLTAGE	POWER TYPE	TEMP/ COLORS	OPTICS	I.P. RATING	LUMENS PER WATT	LUMENS PER MOD	LUMENS PER FT	MODS PER FOOT	WATTS PER MOD	WATTS PER FOOT	MODS PER STRING	MAX MODS IN SERIES	MODS PER 12V / 60W OR 24V / 100W P.S.
NANO	12 VDC	Constant Voltage	7100K	160°	67	100	36	252	7	.36w	2.52w	45	45	166
			5000K	160°	67	94	34	238	7	.36w	2.52w	45	45	166
			3500K	160°	67	94	34	238	7	.36w	2.52w	45	45	166
UNO	12 VDC	Constant Current	7100K	170°	67	148	53	119	2.26	.36w	.82w	45	45	166
			5000K	170°	67	148	53	119	2.26	.36w	.82w	45	45	166
			3500K	170°	67	148	53	119	2.26	.36w	.82w	45	45	166
DUO	12 VDC	Constant Current	7100K	170°	67	155	93	157	1.69	.6w	1.0w	40	40	100
			5000K	170°	67	155	93	157	1.69	.6w	1.0w	40	40	100
			3500K	170°	67	155	93	157	1.69	.6w	1.0w	40	40	100
TRIO	12 VDC	Constant Current	7100K	170°	67	154	148	222	1.5	.96w	1.44w	25	25	60
			5000K	170°	67	154	148	222	1.5	.96w	1.44w	25	25	60
			3500K	170°	67	154	148	222	1.5	.96w	1.44w	25	25	60
UNO	24 VDC	Constant Current	7100K	170°	67	148	53	119	2.26	.36w	.82w	45	45	266
			5000K	170°	67	148	53	119	2.26	.36w	.82w	45	45	266
			3500K	170°	67	148	53	119	2.26	.36w	.82w	45	45	266
DUO	24 VDC	Constant Current	7100K	170°	67	155	93	157	1.69	.6w	1.0w	40	40	160
			5000K	170°	67	155	93	157	1.69	.6w	1.0w	40	40	160
			3500K	170°	67	155	93	157	1.69	.6w	1.0w	40	40	160
TRIO	24 VDC	Constant Current	7100K	170°	67	154	148	222	1.5	.96w	1.44w	25	25	100
			5000K	170°	67	154	148	222	1.5	.96w	1.44w	25	25	100
			3500K	170°	67	154	148	222	1.5	.96w	1.44w	25	25	100
QUATTRO	24 VDC	Constant Current	7100K	170°	67	153	184	276	1.5	1.2w	1.8w	40	40	80
			5000K	170°	67	153	184	276	1.5	1.2w	1.8w	40	40	80
			3500K	170°	67	153	184	276	1.5	1.2w	1.8w	40	40	80



FRANCE TRULUME LED MODULES NAVIGATION

12v NANO | 12v UNO | 12v DUO | 12v TRIO | 24v UNO | 24v DUO | 24v TRIO | 24v QUATTRO

WHITE LED COMPARISON CHART | COLOR LED COMPARISON CHART

LED MODULES COMPARISON CHART

COLOR LED MODULES

EVERY MODULE COMES IN THESE COLORS

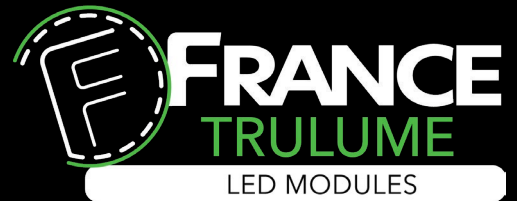

RED



GREEN

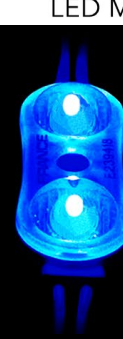

BLUE

COLOR LED MODULES COMPARISON CHART

TRULUME MODULE MODEL	VOLTS	POWER TYPE	TEMP/ COLORS	OPTICS	I.P. RATING	LUMENS PER WATT	LUMENS PER MOD	NOMINAL WAVELENGTH	MODS PER FOOT	WATTS PER MOD	WATTS PER FOOT	MODS PER STRING	MAX MODS IN SERIES	MODS PER 12V / 60W OR 24V / 100W P.S.
NANO	12 VDC	Constant Voltage	RED	160°	67	33	12	625	7	.36w	2.52w	45	45	166
			GREEN	160°	67	41	15	522	7	.36w	2.52w	45	45	166
			BLUE	160°	67	19	7	470	7	.36w	2.52w	45	45	166
UNO	12 VDC	Constant Current	RED	170°	67	38	14	625	2.26	.36w	.82w	45	45	166
			GREEN	170°	67	50	18	522	2.26	.36w	.82w	45	45	166
			BLUE	170°	67	19	7	470	2.26	.36w	.82w	45	45	166
DUO	12 VDC	Constant Current	RED	170°	67	46	28	625	1.69	.6w	1.0w	40	40	100
			GREEN	170°	67	60	36	522	1.69	.6w	1.0w	40	40	100
			BLUE	170°	67	23	14	470	1.69	.6w	1.0w	40	40	100
TRIO	12 VDC	Constant Current	RED	170°	67	43	42	625	1.5	.96w	1.44w	25	25	60
			GREEN	170°	67	56	54	522	1.5	.96w	1.44w	25	25	60
			BLUE	170°	67	21	21	470	1.5	.96w	1.44w	25	25	60
UNO	24 VDC	Constant Current	RED	170°	67	38	14	625	2.26	.36w	.82w	45	45	266
			GREEN	170°	67	50	18	522	2.26	.36w	.82w	45	45	266
			BLUE	170°	67	19	7	470	2.26	.36w	.82w	45	45	266
DUO	24 VDC	Constant Current	RED	170°	67	46	28	625	1.69	.6w	1.0w	40	40	160
			GREEN	170°	67	60	36	522	1.69	.6w	1.0w	40	40	160
			BLUE	170°	67	23	14	470	1.69	.6w	1.0w	40	40	160
TRIO	24 VDC	Constant Current	RED	170°	67	43	42	625	1.5	.96w	1.44w	25	25	100
			GREEN	170°	67	56	54	522	1.5	.96w	1.44w	25	25	100
			BLUE	170°	67	21	21	470	1.5	.96w	1.44w	25	25	100
QUATTRO	24 VDC	Constant Current	RED	170°	67	38	45	625	1.5	1.2w	1.8w	40	40	80
			GREEN	170°	67	47	45	522	1.5	1.2w	1.8w	40	40	80
			BLUE	170°	67	14	16	470	1.5	1.2w	1.8w	40	40	80



FRANCE TRULUME LED MODULES NAVIGATION

12v NANO | 12v UNO | 12v DUO | 12v TRIO | 24v UNO | 24v DUO | 24v TRIO | 24v QUATTRO

WHITE LED COMPARISON CHART | COLOR LED COMPARISON CHART

LED MODULES SELECTION GUIDE

CLICK ON THE ICONS BELOW TO NAVIGATE THE SELECTION GUIDE



ILLUMINATED LETTERS



BOX & CLOUD SIGNS

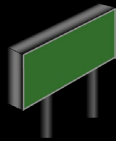

MONUMENT & CABINET SIGNS



ARCHITECTURAL & ACCENT LIGHTING

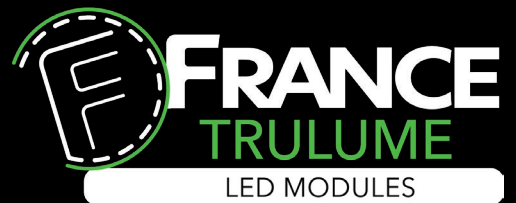

ILLUMINATED LETTERS

WHITE LED MODULES APPLICATION CHART

TRULUME MODULE MODEL	STANDARD CHANNEL LETTERS	SHALLOW CHANNEL LETTERS	DEEP CHANNEL LETTERS	WIDE CHANNEL LETTERS	THIN CHANNEL LETTERS	HALO LIT CHANNEL LETTERS	HALO LIT ROUTED LETTERS	SMALL MOLDED & ACRYLIC LETTERS (I.E. GEMINI)
12v NANO	☹️	😊	☹️	☹️	😊	😊	😊	😊
12v UNO	😊	😊	☹️	😊	😊	😊	😊	😊
12v DUO	😊	😊	☹️	😊	☹️	😊	😊	☹️
12v TRIO	😊	😊	😊	😊	☹️	😊	☹️	☹️
24v UNO	😊	😊	☹️	😊	😊	😊	😊	😊
24v DUO	😊	😊	☹️	😊	☹️	😊	😊	☹️
24v TRIO	😊	😊	😊	😊	☹️	😊	☹️	☹️
24v QUATTRO	😊	☹️	😊	😊	☹️	😊	☹️	☹️

😊 YES ☹️ NO 😊 NOT OPTIMAL - REQUIRES ADJUSTMENTS AND OR GUIDANCE FROM FRANCE

COLOR LED MODULES APPLICATIONS GUIDE

TRULUME MODULE MODEL	STANDARD CHANNEL LETTERS	SHALLOW CHANNEL LETTERS	DEEP CHANNEL LETTERS	WIDE CHANNEL LETTERS	THIN CHANNEL LETTERS	HALO LIT CHANNEL LETTERS	HALO LIT ROUTED LETTERS	SMALL MOLDED & ACRYLIC LETTERS (I.E. GEMINI)
12v NANO	☹️	😊	☹️	☹️	😊	😊	😊	😊
12v UNO	😊	😊	☹️	😊	😊	😊	😊	😊
12v DUO	😊	😊	☹️	😊	☹️	😊	😊	☹️
12v TRIO	😊	😊	😊	😊	☹️	😊	☹️	☹️
24v UNO	😊	😊	☹️	😊	😊	😊	😊	😊
24v DUO	😊	😊	☹️	😊	☹️	😊	😊	☹️
24v TRIO	😊	😊	😊	😊	☹️	😊	☹️	☹️
24v QUATTRO	😊	☹️	😊	😊	☹️	😊	☹️	☹️

😊 YES ☹️ NO 😊 NOT OPTIMAL - REQUIRES ADJUSTMENTS AND OR GUIDANCE FROM FRANCE



FRANCE TRULUME LED MODULES NAVIGATION

12v NANO | 12v UNO | 12v DUO | 12v TRIO | 24v UNO | 24v DUO | 24v TRIO | 24v QUATTRO

WHITE LED COMPARISON CHART | COLOR LED COMPARISON CHART

LED MODULES SELECTION GUIDE



CLICK ON THE ICONS BELOW TO NAVIGATE THE SELECTION GUIDE



BOX & CLOUD SIGNS

LED WHITE MODULES APPLICATIONS GUIDE

TRULUME MODULE MODEL	STANDARD 5" - 8" DEPTH	SHALLOW 3" - 5" DEPTH	DEEPER 9" - 12" DEPTH	APPLICATION NOTES
12v DUO	☹️	😊	☹️	IF SPACING BETWEEN MODULE IS DECREASED A 2" DEPTH IS POSSIBLE
12v TRIO	😊	😊	☹️	PAST A 6" DEPTH THE TRIO MAY NOT PROVIDE THE DESIRED BRIGHTNESS
24v DUO	☹️	😊	☹️	IF SPACING BETWEEN MODULE IS DECREASED A 2" DEPTH IS POSSIBLE
24v TRIO	😊	😊	☹️	PAST A 6" DEPTH THE TRIO MAY NOT PROVIDE THE DESIRED BRIGHTNESS
24v QUATTRO	😊	☹️	😊	THE QUATTRO WAS BUILT FOR THIS TYPE OF APPLICATION

😊 YES ☹️ NO ☹️ NOT OPTIMAL - REQUIRES ADJUSTMENTS AND OR GUIDANCE FROM FRANCE

LED COLOR MODULES APPLICATIONS GUIDE

TRULUME MODULE MODEL	STANDARD 5" - 8" DEPTH	SHALLOW 3" - 5" DEPTH	DEEPER 9" - 12" DEPTH	APPLICATION NOTES
12v DUO	☹️	😊	☹️	IF SPACING BETWEEN MODULE IS DECREASED A 2" DEPTH IS POSSIBLE
12v TRIO	😊	😊	☹️	PAST A 6" DEPTH THE TRIO MAY NOT PROVIDE THE DESIRED BRIGHTNESS
24v DUO	☹️	😊	☹️	IF SPACING BETWEEN MODULE IS DECREASED A 2" DEPTH IS POSSIBLE
24v TRIO	😊	😊	☹️	PAST A 6" DEPTH THE TRIO MAY NOT PROVIDE THE DESIRED BRIGHTNESS
24v QUATTRO	😊	☹️	😊	THE QUATTRO WAS BUILT FOR THIS TYPE OF APPLICATION

😊 YES ☹️ NO ☹️ NOT OPTIMAL - REQUIRES ADJUSTMENTS AND OR GUIDANCE FROM FRANCE



FRANCE TRULUME LED MODULES NAVIGATION

12v NANO | 12v UNO | 12v DUO | 12v TRIO | 24v UNO | 24v DUO | 24v TRIO | 24v QUATTRO
 WHITE LED COMPARISON CHART | COLOR LED COMPARISON CHART

LED MODULES SELECTION GUIDE

CLICK ON THE ICONS BELOW TO NAVIGATE THE SELECTION GUIDE



ILLUMINATED LETTERS



BOX & CLOUD SIGNS



MONUMENT & CABINET SIGNS



ARCHITECTURAL & ACCENT LIGHTING

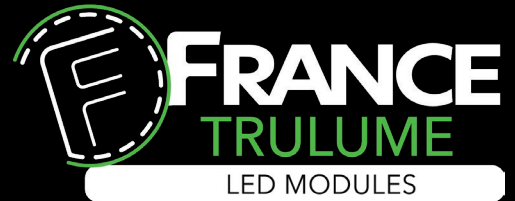

MONUMENTS & CABINETS

LED MODULES APPLICATIONS GUIDE

TRULUME MODULE MODEL	SHALLOW DOUBLE SIDED 6" - 11" DEPTH	STANDARD DOUBLE SIDED 12" - 18" DEPTH	DEEP DOUBLE SIDED 18" - 24" DEPTH	APPLICATION NOTES <i>PRODUCTS NEED MOUNTED TO YOUR EXTRUSION OF CHOICE</i>
12v TRIO	☹️	☹️	☹️	6" - 8" DEPTHS REQUIRES PULLING THE MODULES IN TIGHTER
24v TRIO	☹️	☹️	☹️	6" - 8" DEPTHS REQUIRES PULLING THE MODULES IN TIGHTER
24v QUATTRO	☹️	😊	😊	18" OR DEEPER REQUIRES PULLING THE MODULES IN TIGHTER

😊 YES ☹️ NO ☹️ NOT OPTIMAL - REQUIRES ADJUSTMENTS AND OR GUIDANCE FROM FRANCE

MODULE INSTALLATION GUIDE FOR DIY LED DOUBLE SIDED STICK

12v TRULUME TRIO DIY INSTALLATION GUIDE FOR DEPTH RANGE OF 8" - 16" > DOUBLE SIDED

T 12 SIZES >	18"	24"	30"	36"	42"	48"	60"	64"	72"	84"	96"	108"	117"	120"
MODULES PER DOUBLE SIDED STICK	6	6	8	10	12	12	16	18	18	22	24	28	30	30
LUMENS PER DOUBLE SIDED STICK	888	888	1184	1480	1776	1776	2368	2664	2664	3256	3552	4144	4440	4440
# OF STICKS ON A 12V / 120W P.S.	20.5	20.5	15.5	12.5	10	10	7.5	6.5	6.5	5.5	5	4	4	4

24v TRULUME TRIO DIY INSTALLATION GUIDE FOR DEPTH RANGE OF 8" - 16" > DOUBLE SIDED

T 12 SIZES >	18"	24"	30"	36"	42"	48"	60"	64"	72"	84"	96"	108"	117"	120"
MODULES PER DOUBLE SIDED STICK	6	6	8	10	12	12	16	18	18	22	24	28	30	30
LUMENS PER DOUBLE SIDED STICK	888	888	1184	1480	1776	1776	2368	2664	2664	3256	3552	4144	4440	4440
# OF STICKS ON A 12V / 120W P.S.	20.5	20.5	15.5	12.5	10	10	7.5	6.5	6.5	5.5	5	4	4	4

24v TRULUME QUATTRO DIY INSTALLATION GUIDE FOR DEPTH RANGE OF 10" - 20" > DOUBLE SIDED

T 12 SIZES >	18"	24"	30"	36"	42"	48"	60"	64"	72"	84"	96"	108"	117"	120"
MODULES PER DOUBLE SIDED STICK	6	6	8	10	12	12	16	18	18	22	24	28	30	30
LUMENS PER DOUBLE SIDED STICK	1104	1104	1472	1840	2208	2208	2944	3312	3312	4048	4416	5152	5520	5520
# OF STICKS ON A 24V / 100W P.S.	13	13	10	8	6.5	6.5	5	4	4	3.5	3	2.5	2.5	2.5



FRANCE TRULUME LED MODULES NAVIGATION

12v NANO | 12v UNO | 12v DUO | 12v TRIO | 24v UNO | 24v DUO | 24v TRIO | 24v QUATTRO

WHITE LED COMPARISON CHART | COLOR LED COMPARISON CHART

CORNBULB / SIGN KIT SELECTION GUIDE

CLICK ON THE ICONS BELOW TO NAVIGATE THE SELECTION GUIDE



ILLUMINATED LETTERS



BOX & CLOUD SIGNS



MONUMENT & CABINET SIGNS



ARCHITECTURAL & ACCENT LIGHTING

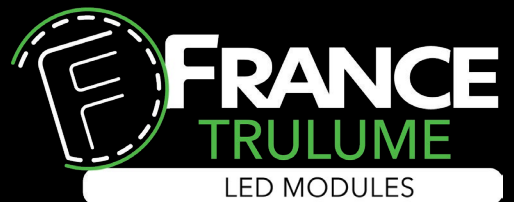

MONUMENTS & CABINETS
ULTRA DEEP

CORNBULB / SIGN KIT APPLICATIONS CHART

CORNBULB MODEL	TRUBRITE CORNBULBS	ULTRA DEEP DOUBLE SIDED MIN. OF 28" DEEP	ULTRA DEEP DOUBLE SIDED MIN. OF 30" DEEP	ULTRA DEEP DOUBLE SIDED MIN. OF 33" DEEP	ULTRA DEEP DOUBLE SIDED MIN. OF 36" DEEP
MGLED -54W	54W	😊	😐	😞	😞
MGLED -75W	75W	😞	😊	😐	😞
MGLED -100W	100W	😞	😞	😊	😐
MGLED -120W	120W	😞	😞	😞	😊

😊 YES 😞 NO 😐 NOT OPTIMAL - REQUIRES ADJUSTMENTS AND OR GUIDANCE FROM FRANCE

CORNBULB COMPARISON CHART

TRUBRITE GEN II - 5000K CORNBULBS

CORNBULB MODEL	WATTAGE	RATED CURRENT	HID EQUIVALENT	CFL EQUIVALENT	LUMEN OUTPUT	# OF LEDS	MOGUL CONNECTION	WEIGHT
MGLED -54W	54W	0.54A	175W - 200W	105W	7020 lm	195 pcs	E39	2.64 lbs
MGLED -75W	75W	0.75A	200W - 250W	150W	9750 lm	234 pcs	E39	3.17 lbs
MGLED -100W	100W	1.0A	250W - 320W	200W	13000 lm	416 pcs	E39	3.96 lbs
MGLED -120W	120W	1.2A	320W - 400W	250W	15600 lm	507 pcs	E39	4.40 lbs

CORNBULBS INSTALLATION GUIDE

TRUBRITE CORNBULB / SIGN KITS GUIDE > DOUBLE SIDED

CORNBULB / SIGN KIT WATTAGE	54W	75W	100W	120W
RECOMMENDED CABINET DEPTH	28"	30"	33"	36"
RECOMMENDED LAMP TO LAMP SPACING	30"	36"	42"	48"
# OF LAMPS IN A 12FT. X 12FT. CABINET	23	16	12	9

CHECK OUT OUR



FRANCE TRULUME LED MODULES NAVIGATION

12v NANO | 12v UNO | 12v DUO | 12v TRIO | 24v UNO | 24v DUO | 24v TRIO | 24v QUATTRO
WHITE LED COMPARISON CHART | COLOR LED COMPARISON CHART

LED MODULES SELECTION GUIDE

CLICK ON THE ICONS BELOW TO NAVIGATE THE SELECTION GUIDE



ILLUMINATED LETTERS



BOX & CLOUD SIGNS



MONUMENT & CABINET SIGNS



ARCHITECTURAL & ACCENT LIGHTING

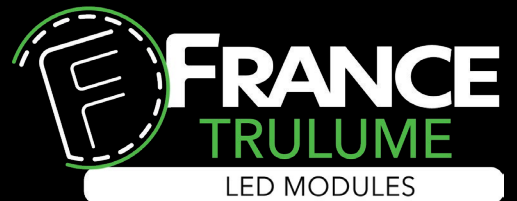

ARCHITECTURAL & ACCENT LIGHTING

WHITE MODULES APPLICATIONS CHART

TRULUME MODULE MODEL	COVE LIGHTING	HALO LIGHTING	BUILDING ACCENTS	NEON REPLACEMENT	APPLICATION NOTES
12v NANO	😊	😊	SEE FRANCE FLEXX CURV		WITH THE AMOUNT OF VARIABLES TO CONSIDER WHEN SELECTING THE RIGHT LIGHT SOURCE FOR THESE TYPES OF PROJECTS, WE HIGHLY ENCOURAGE YOU TO CONTACT A FRANCE LED SPECIALIST.
12v UNO	😊	😊	SEE FRANCE FLEXX CURV		
12v DUO	😊	😊	SEE FRANCE FLEXX CURV		
12v TRIO	😊	😊	SEE FRANCE FLEXX CURV		
24v UNO	😊	😊	SEE FRANCE FLEXX CURV		
24v DUO	😊	😊	SEE FRANCE FLEXX CURV		
24v TRIO	😊	😊	SEE FRANCE FLEXX CURV		
24v QUATTRO	😊	😊	SEE FRANCE FLEXX CURV		

😊 YES 😞 NO 😐 NOT OPTIMAL - REQUIRES ADJUSTMENTS AND OR GUIDANCE FROM FRANCE

COLOR MODULES APPLICATIONS CHART

TRULUME MODULE MODEL	COVE LIGHTING	HALO LIGHTING	BUILDING ACCENTS	NEON REPLACEMENT	APPLICATION NOTES
12v NANO	😊	😊	SEE FRANCE FLEXX CURV		WITH THE AMOUNT OF VARIABLES TO CONSIDER WHEN SELECTING THE RIGHT LIGHT SOURCE FOR THESE TYPES OF PROJECTS, WE HIGHLY ENCOURAGE YOU TO CONTACT A FRANCE LED SPECIALIST.
12v UNO	😊	😊	SEE FRANCE FLEXX CURV		
12v DUO	😊	😊	SEE FRANCE FLEXX CURV		
12v TRIO	😊	😊	SEE FRANCE FLEXX CURV		
24v UNO	😊	😊	SEE FRANCE FLEXX CURV		
24v DUO	😊	😊	SEE FRANCE FLEXX CURV		
24v TRIO	😊	😊	SEE FRANCE FLEXX CURV		
24v QUATTRO	😊	😊	SEE FRANCE FLEXX CURV		

😊 YES 😞 NO 😐 NOT OPTIMAL - REQUIRES ADJUSTMENTS AND OR GUIDANCE FROM FRANCE



FRANCE TRULUME LED MODULES NAVIGATION

12v NANO | 12v UNO | 12v DUO | 12v TRIO | 24v UNO | 24v DUO | 24v TRIO | 24v QUATTRO

WHITE LED COMPARISON CHART | COLOR LED COMPARISON CHART

FranceLEDProducts.com - 800.793.4793 - 2268 Fairview Blvd., Fairview, TN 37062